

PROJECT:	TYPE:
LOCATION:	CAT:

Description

Flexible LED linear lighting that mimics the look of neon in a brighter, longer lasting format that consumes less power

Features

- PU construction provides excellent UV, salt water, chlorine, high temperature, and impact resistance
- Weatherproof IP67 outdoor rating
- SPI WS2811 protocol, addressable every 7 LEDs
- Requires the use of DMX 512 master control and SPI decoder (not included)
- Lateral flexibility (relative to light source)
- Quick-ship skus or special order options

Mounting

Aluminum channel or mounting clips

Applications

Outlining building facades and roof-lines, columns and pillars, coves and eaves

Warranty

5 Years

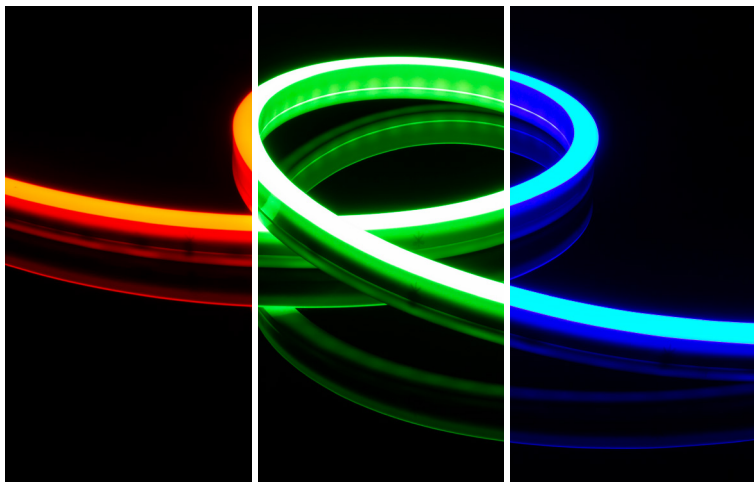

Technical Information

Input Voltage	24V DC Constant Voltage
Max Current	0.5A per meter / 0.15A per foot
Max Power	12W per meter / 3.65W per foot
Color	Digital Pixel RGB
Lumens	91Lm/ft
Cut Increments	100mm (3.94")
Max Run	10 meters (32.8 feet) interconnected
Control	Requires WS2811 Protocol Control
Address	1 IC controls 7 LEDs
Ambient Temp	-30°C (-22°F) to 80°C (176°F)**
Rating	cETLus Listed; Indoor/Outdoor; IP67
Rated Life	50,000 Hours

*Minimum loads may apply. Per the NEC, switched wall outlets cannot be used with wall dimmers. **Do not install during inclement weather or extreme temperature conditions (i.e. -25°C (-13°F) and below)

Side Profile

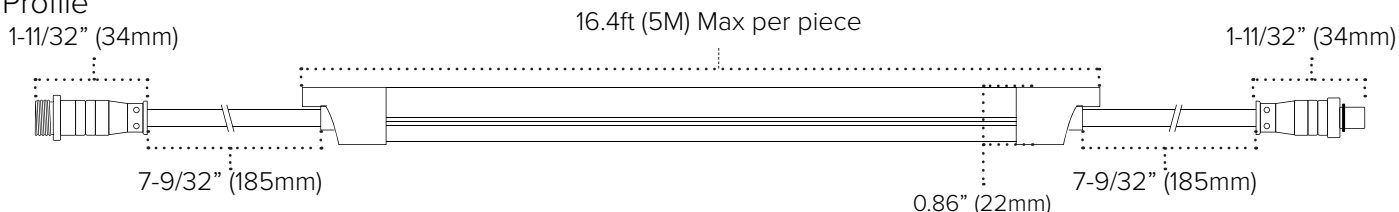

Top Profile

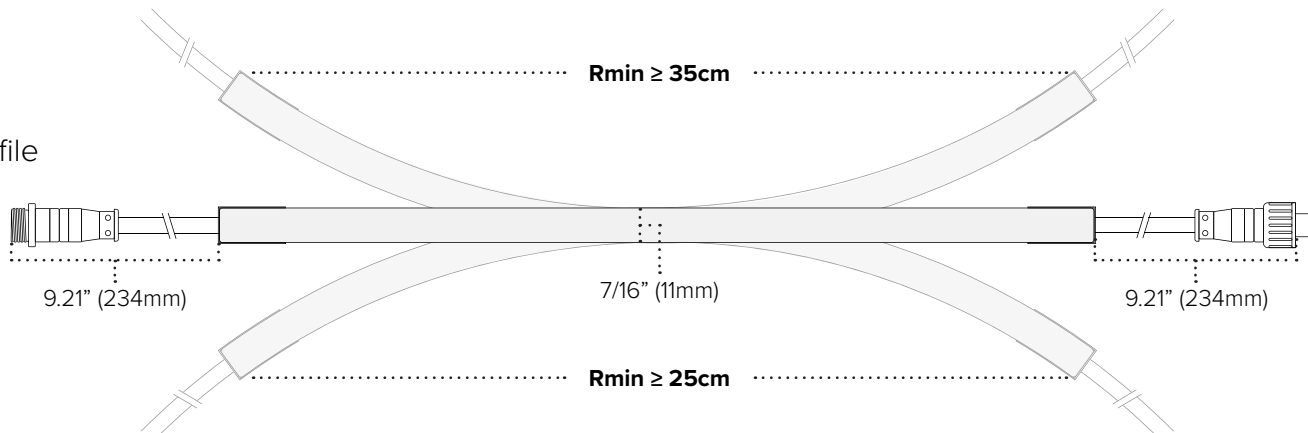

Quick-Ship Order Information

FIXTURE	ITEM NUMBER
4FT NEOFLUX L-SERIES Pixel RGB (48-3/4" length)	PZM-NFL-4-PXL-RGB
8FT NEOFLUX L-SERIES Pixel RGB (96-1/2" length)	PZM-NFL-8-PXL-RGB
ACCESSORY	ITEM NUMBER
4FT ALUMINUM CHANNEL FOR NEOFLUX L-SERIES	PZM-NFL-CHAN-4
4FT FLEXIBLE ALUMINUM CHANNEL FOR NEOFLUX L-SERIES (SPECIAL ORDER)	PZM-NFL-CHANFLEX-4
1FT 3PIN JUMPER CABLE FOR NEOFLUX PIXEL RGB	PZM-NF-3JUMP1
10FT 3PIN JUMPER CABLE FOR NEOFLUX PIXEL RGB	PZM-NF-3JUMP10
3PIN T-CONNECTOR CABLE FOR NEOFLUX PIXEL RGB	PZM-NF-3TCON
BAG OF 8 MOUNTING BRACKET FOR NEOFLUX L-SERIES	PZM-NFL-CLIPS
BAG OF 10 END CAPS FOR NEOFLUX L-SERIES	PZ-NFL-END

Control Accessories

Image	Part Number	Description
	PZM-DEC-SPI	SPI DECODER • WS2811 • 5-36VDC • Use with a DMX control (not included)

Special Order Information

Please allow 12-16 weeks for special order items

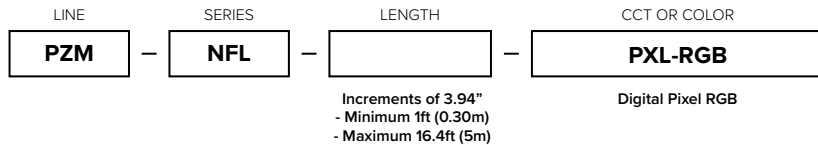

For special orders, please contact us at: Quotes@PrizmLighting.com

Recommended Power Supplies

SERIES	RATED POWER AVAILABLE
LED-DR Series	30W, 60W, 96W, 150W
ADPT-DRJ Series	30W, 60W, 96W

PZM-NFL-CHAN-4 Dimensions

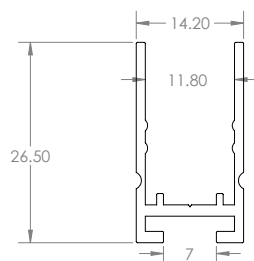

Products and specification sare subject to change without notice.